

### Crémaillère à encastrer par l'arrière

Slot channel sunk from behind

Longueur / Length: 1532 / 2013 / 2531 mm

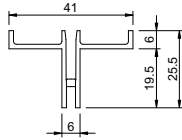
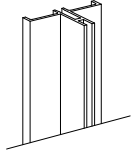

• Réf / Art. no. **M1915 / M1920 / M1925**

### Cabochon de finition pour crémaillère M19

Finishing end cap for slot channel M19

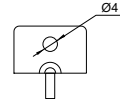

• Réf / Art. no. **CABM19**

### Support + ventouses pour tablette verre

Bracket + suckers for glass shelf

Profondeur / Standout: 200 / 300 mm

Charge maxi. / Safe load: 20 kg

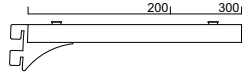
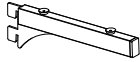

• Réf / Art. no. **LTTAB20V / LTTAB30V**

### Support + tourillons pour tablette bois

Bracket + pins for wood shelf

Profondeur / Standout: 200 / 300 mm

Charge maxi. / Safe load: 20 kg

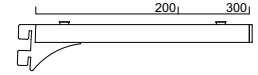
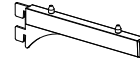

• Réf / Art. no. **LTTAB20B / LTTAB30B**

### Support en T + ventouses pour tablette verre

T-bracket + suckers for glass shelf

Profondeur / Standout: 315 mm  
Largeur / Width: 590 mm

Charge maxi. / Safe load: 10 kg

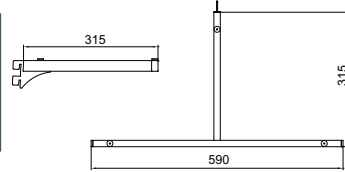
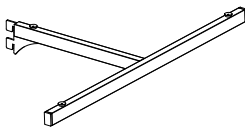

• Réf / Art. no. **LTTABTV**

### Support en T + tourillons pour tablette bois

T-bracket + pins for wood shelf

Profondeur / Standout: 315 mm  
Largeur / Width: 590 mm

Charge maxi. / Safe load: 10 kg

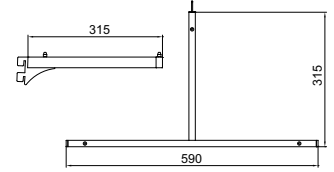
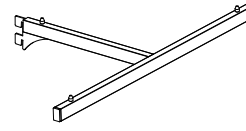

• Réf / Art. no. **LTTABTB**

### Support pendu côté / plié + ventouses pour tablette verre

Folded / side-hung bracket + suckers for glass shelf

Charge maxi. / Safe load: 20 kg

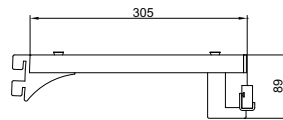
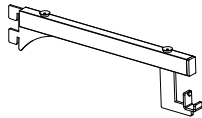

• Réf / Art. no. **LTBPTABV**

### Support pendu côté / plié + tourillons pour tablette bois

Folded / side-hung bracket + pins for wood shelf

Charge maxi. / Safe load: 20 kg

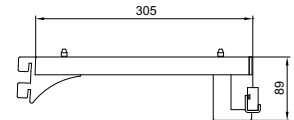
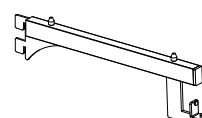

• Réf / Art. no. **LTBPTABB**

### Support pour barre penderie

Clothes rail bracket

Charge maxi. / Safe load: 20 kg

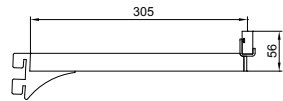
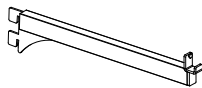

• Réf / Art. no. **LTSUPBP**

### Barre penderie 25 x 15 mm pour entraxes 600 et 800 mm

Clothes rail 25 x 15 mm for 600 or 800-mm centre width

Longueur / Length: 1190 mm

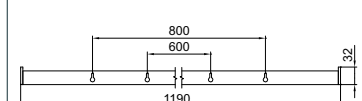
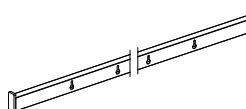

• Réf / Art. no. **LBP12**

### Ensemble penderie en T

T-shaped clothes rail set

Longueur / Length: 590 mm

Charge maxi. / Safe load: 10 kg

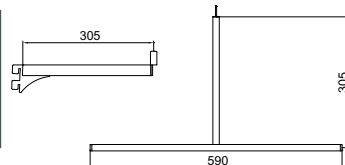
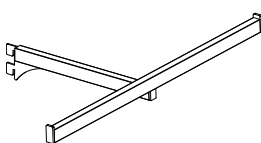

• Réf / Art. no. **LTBPT**

### Bras droit

Straight arm

Profondeur / Standout: 200 / 300 mm

Charge maxi. / Safe load: 25 kg

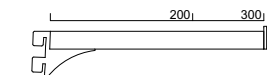

• Réf / Art. no. **LTBRA20T / LTBRA30T**

**Bras deux niveaux**

*Stepped arm*

Profondeur / Standout: 300 mm

Charge maxi. / Safe load: 25 kg

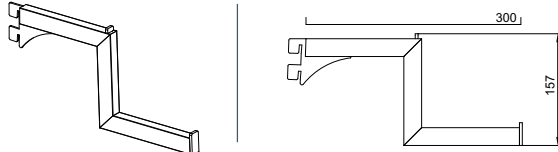

• Réf / Art. no. **LTBRA2NT**

**Bras perroquet**

*Sloping arm*

Profondeur / Standout: 300 mm

Nombre de picots / Number of pins: 9

Charge maxi. / Safe load: 25 kg

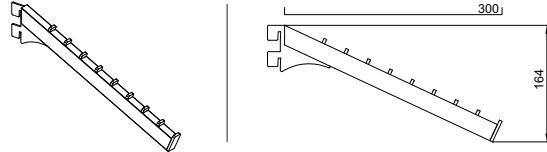

• Réf / Art. no. **LTPERT**

**Présentoir à chaussure**

*Footwear display*

Profondeur / Standout: 110 mm  
Largeur / Width: 250 mm

Charge maxi. / Safe load: 6 kg

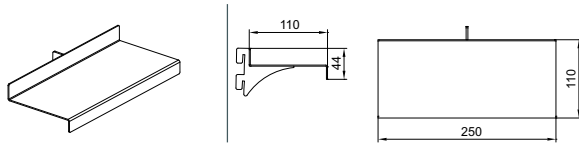

• Réf / Art. no. **LTCHAUSS**

**Ensemble barre de charge 25 x 15 mm**

*Support rail 25 x 15 mm*

Entraxe / Centre width: 600 / 800 mm

Charge maxi. / Safe load: 60 kg

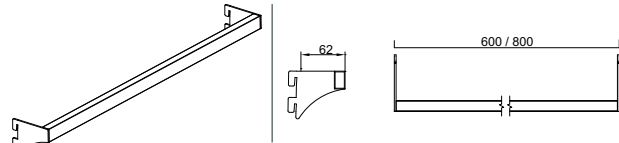

• Réf / Art. no. **LTBC60 / LTBC80**

**Bras droit pour barre de charge**

*Straight arm for support rail*

Profondeur / Standout: 200 / 300 mm

Charge maxi. / Safe load: 20 kg

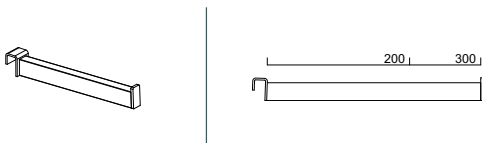

• Réf / Art. no. **LTBRA20C / LTBRA30C**

**Bras deux niveaux pour barre de charge**

*Stepped arm for support rail*

Profondeur / Standout: 300 mm

Charge maxi. / Safe load: 20 kg

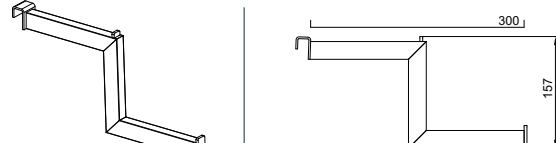

• Réf / Art. no. **LTBRA2NC**

**Bras perroquet pour barre de charge**

*Sloping arm for support rail*

Profondeur / Standout: 300 mm  
Nombre de picots / Number of pins: 9

Charge maxi. / Safe load: 20 kg

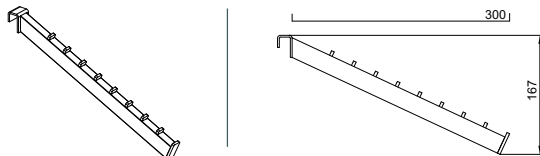

• Réf / Art. no. **LTPERC**

**Broche blister pour barre de charge**

*Blister hook for support rail*

Profondeur / Standout: 200 mm

Charge maxi. / Safe load: 3 kg

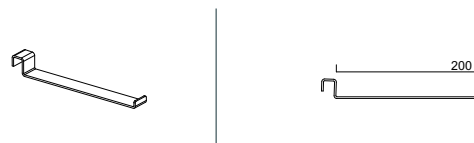

• Réf / Art. no. **LTBLIS**

**Broche en fil carré de 6 x 6 mm pour barre de charge**

*Square hook 6 x 6 mm for support rail*

Profondeur / Standout: 200 mm

Charge maxi. / Safe load: 3 kg



• Réf / Art. no. **LTBRO**

**Module multi-broches en fil carré de 6 x 6 mm pour barre de charge**

*Set of square hooks 6 x 6 mm for support rail*

Profondeur / Standout: 200 mm  
Largeur / Width: 290 mm

Charge maxi. / Safe load: 10 kg

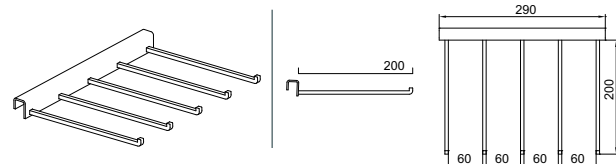

• Réf / Art. no. **LT5BRO**

ATTENTION : La charge maximale est indiquée par support. Pour les supports de tablette et de barre de penderie, il faut donc multiplier par 2 la charge maximale et veiller à soustraire le poids de la tablette. Veillez à toujours répartir la charge de façon homogène sur l'ensemble des supports ou des tablettes.

ATTENTION: specified safe load per bracket. Multiply by two for clothes rail brackets and shelf brackets, then deduct shelf weight. Loads must always be evenly distributed.

# TECHNIQUE CRÉMAILLÈRE M19

## SLOT CHANNEL M19 TECHNIQUE

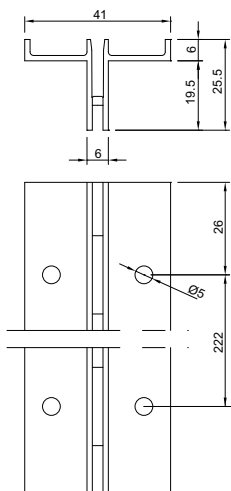

### CRÉMAILLÈRE

Crémaillère à encastrer par l'arrière - réf : M19

### SLOT CHANNEL

Slot channel sunk from behind - Art. no. M19

## MISE EN ŒUVRE / INSTALLATION

### Usinage de la rainure arrêtée

Slot cutting

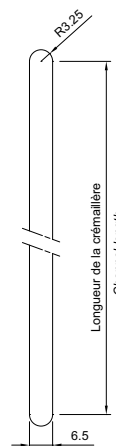
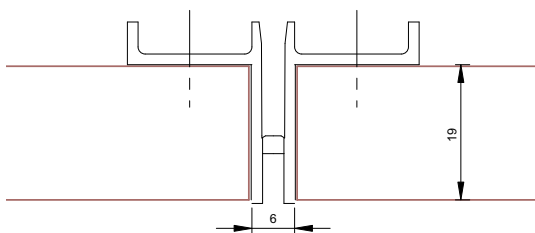

### Pose de la crémaillère

Channel Installation

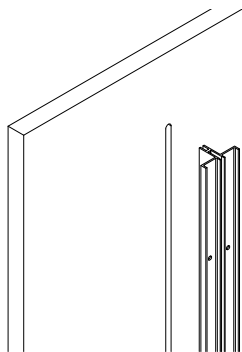

1 - Crémaillère M19.  
Slot channel M19

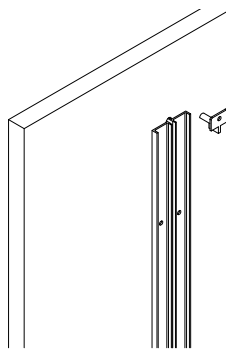

2 - Mise en place M19 et cabochon de finition.  
Fitting of channel M19 & finishing end cap

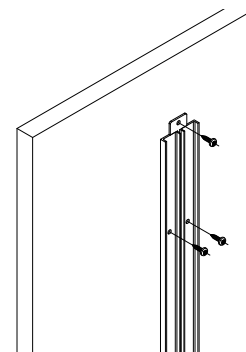

3 - Fixation M19 et cabochon.  
Fixing of channel & end cap

# RECOMMANDATIONS / RECOMMENDATIONS

## Calpinages muraux Wall patterns

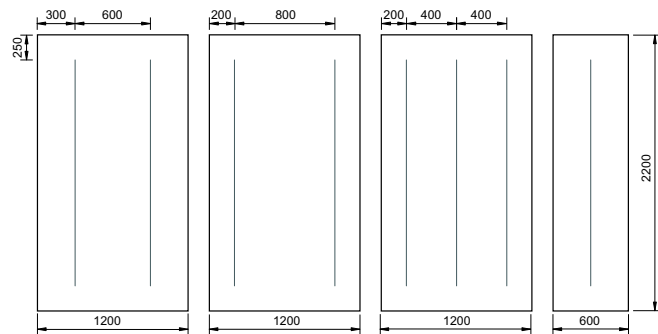

## Calpinages centraux Centre-floor patterns

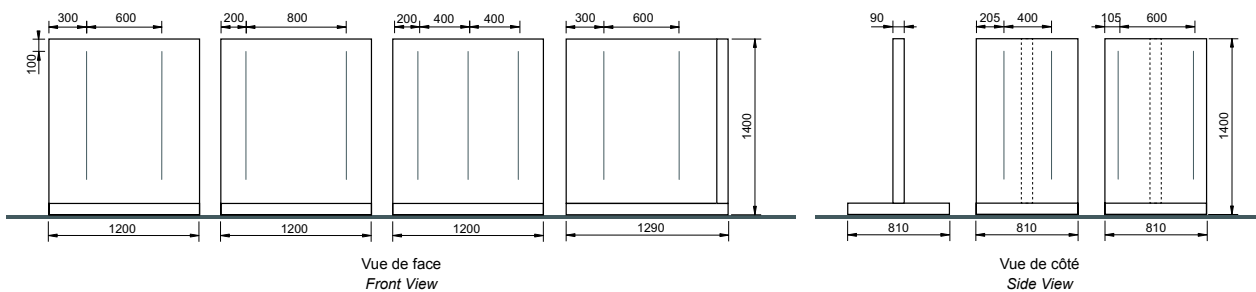

## Fixation du panneau Panel fixing

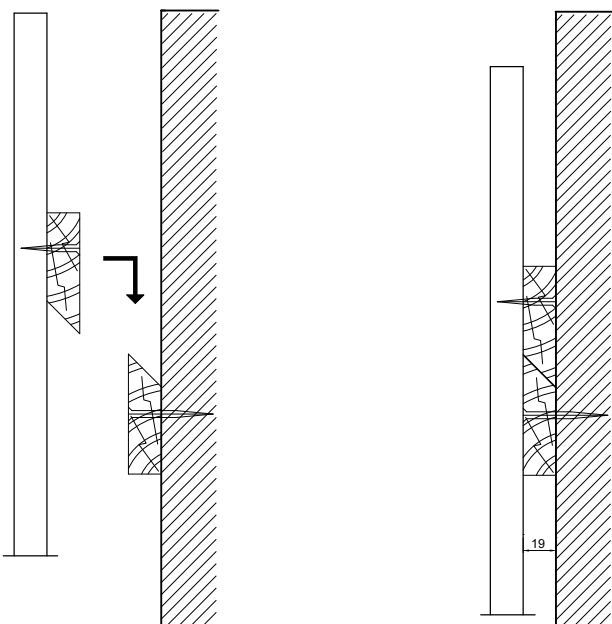

1 - Dans du panneau de 19 mm minimum, fabriquer des clés de dévêtissement. Les poser au dos du panneau et sur le mur.  
Cut wedges as shown, minimum thickness 19 mm. Fix them to the wall and to the backside of the panel.

2 - Mettre en place le panneau sur les clés de dévêtissement posées préalablement.  
Hang the panel on the wedges.

# PRÉCONISATIONS POUR LES TABLETTES

## RECOMMENDATIONS FOR SHELVES

### Dimensions tablettes verre

*Glass shelf dimensions*

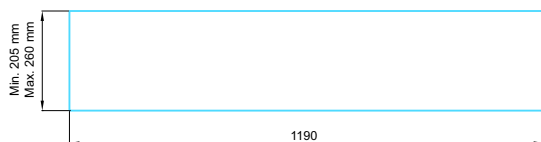

Pour support tablette 200 mm LHTAB20V et LTTAB20V  
For 200-mm shelf brackets LHTAB20V and LTTAB20V

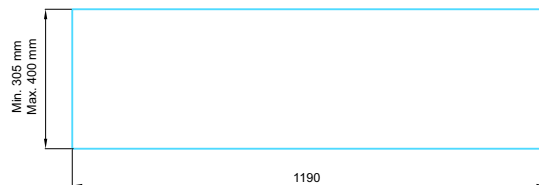

Pour support tablette 300 mm LHTAB30V et LTTAB30V  
Pour support pendu côté / plié LHTABTV et LTBPTABV  
For 300-mm shelf brackets LHTAB30V and LTTAB30V  
For shelf + clothes rail brackets LHTABTV and LTBPTABV



Pour support tablette T LHBPTABV et LTTABTV  
For T-brackets LHBPTABV and LTTABTV

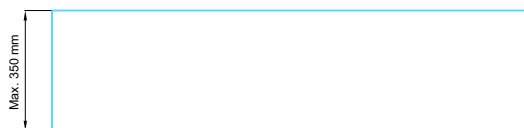

Verre à insérer dans profil H19  
Glass shelf to insert in profile H19

### Montage tablette dans profil H19

*Fitting of shelf in profile H19*

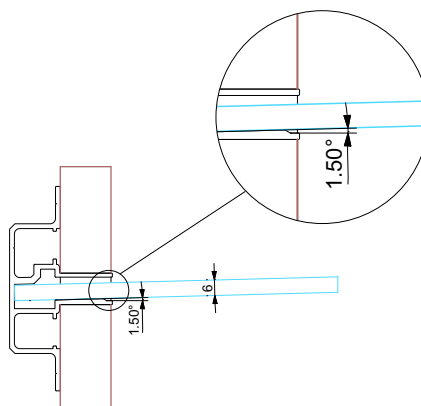
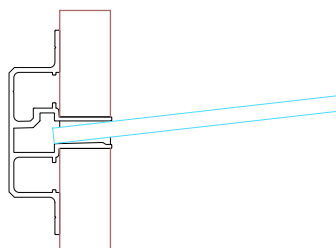

## Dimensions tablettes bois

Wood shelf dimensions

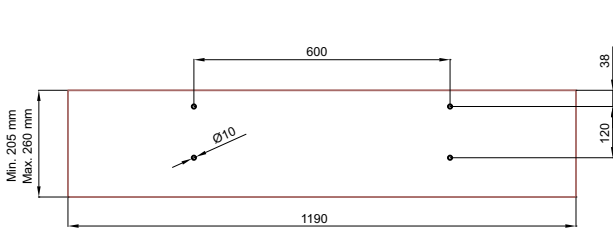

Pour support tablette 200 mm LHTAB20B et LTTAB20B  
For 200-mm shelf brackets LHTAB20B and LTTAB20B

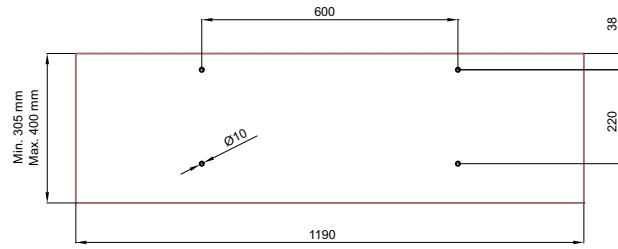

Pour support tablette 300 mm LHTAB30B et LTTAB30B  
Pour support pendu côté / plié LHBPTABB et LTBPTABB  
For 300-mm shelf brackets LHTAB30B and LTTAB30B  
For shelf + clothes rail brackets LHBPTABB and LTBPTABB

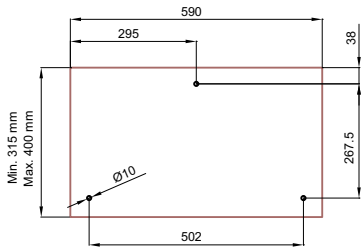

Pour support tablette T LHTABTB et LTTABTB  
For T-brackets LHTABTB and LTTABTB

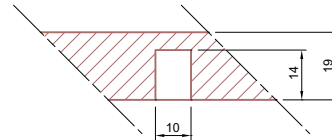

Perçage  
Drilling

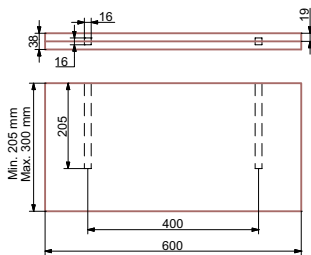

Pour support invisible LHTABIN  
For concealed bracket LHTABIN

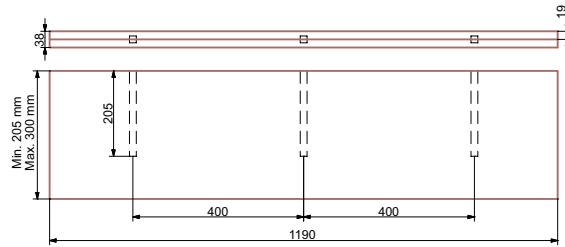

Pour support invisible LHTABIN  
For concealed bracket LHTABIN

## Montage support invisible

Fitting of concealed bracket

